



30W Termination

TN-0030-30NM

Specifications:

Frequency Range:	DC-3 GHz
VSWR:	1.2:1 Max
Power:	30 Watts Avg
Impedance:	50 Ohms
Connector:	N male
Operating Temp.Range:	-20°C to +85°C

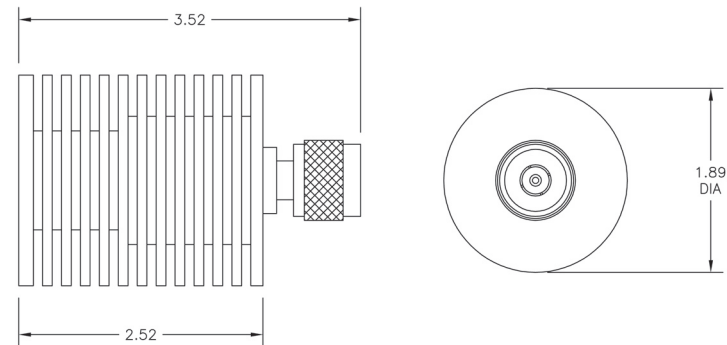
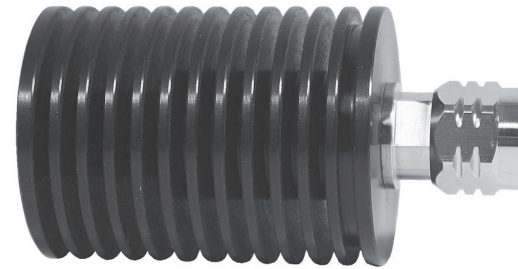

MICROWAVE FILTER CO., INC.
6743 KINNE STREET, E. SYRACUSE, NY 13057
E-Mail: mfcsales@microwavefilter.com

800-448-1666 • 315-438-4700
Web: www.microwavefilter.com